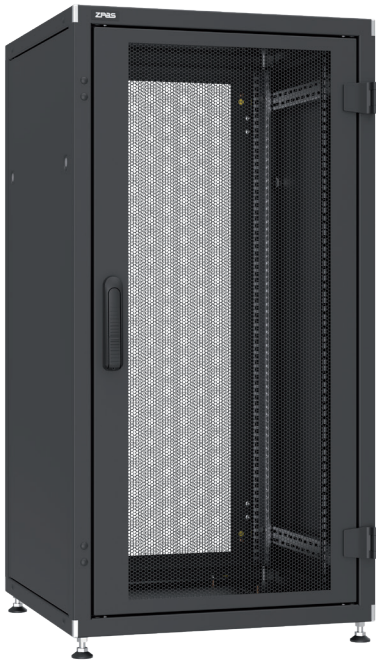

SZB IT Data Communication Cabinet 24 U, 600 x 600 mm

Catalogue number: W-IT-246060-44AA-2-161-FB

ZPAS**PRODUCT DESCRIPTION**

Cabinet for ICT applications based on a bolted frame.
Static load capacity 1000 kg.

Functionality

- 71 mm wide cable openings in the top and bottom plates allow to put thought the power cords with three-phase plug.
- Ventilation perforation in the top plate.
- All openings in the top and bottom plates blanked with knock-out blanking plates.
- U-marking on the mounting profiles.
- Maximum door opening angle: 270°.
- Door opening direction can be changed.
- Doors with optimal perforation clearance of 80%.
- Possibility to put the cabinet directly on the floor (no protruding elements under the cabinet).
- Adaptation for bying the cabinets in the rows.

**CONFIGURATION**

- Bolted frame (bottom plate, top plate, four posts).
- Front single-leaf perforated metal door with single-point lock and swing handle.
- Rear single-leaf perforated metal door with single-point lock and swing handle.
- Two solid metal side panels with single-point locks.
- Two pairs of 19" mounting profiles, type STANDARD.
- Earthing bar.
- Doors and side panels earthing conductors (not shown in photos).
- Four levelling feet.
- **The cabinet is delivered in parts for self-assembly, packed in three cardboard boxes.**

TECHNICAL DATA**Material**

Sheet steel.

Protection degree

IP 20 in accordance with EN 60529.

Surface finishing

Frame, side panels, doors – powder paint, black (RAL 7035).
Mounting profiles, C-profiles – zinc coated.

SZB IT Data Communication Cabinet 24 U, 600 x 600 mm

Catalogue number: W-IT-246060-44AA-2-161-FB



A-A section

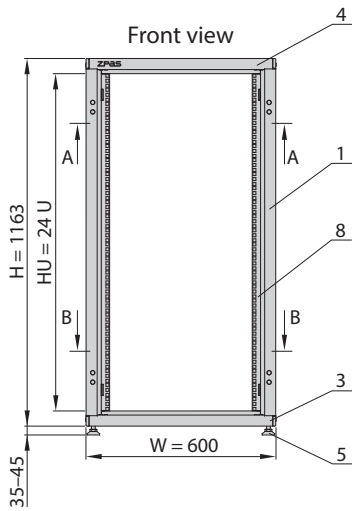
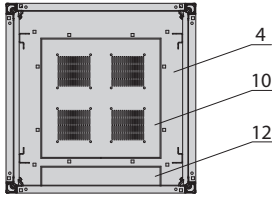

Side view

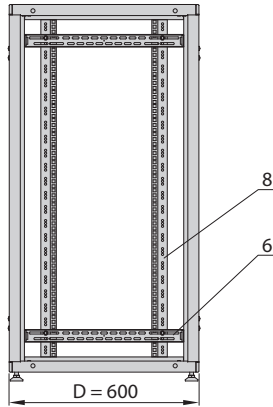

DESIGN

- 1. Frame's post
- 3. Frame's bottom plate
- 4. Frame's top plate
- 5. Adjustable feet
- 6. C-profile for 15 mm deep mounting profiles
- 8. 19" mounting profile, type STANDARD, 15 mm deep
- 9. Earthing bar
- 10. Knock-out blanking plate 380 x 380 mm
- 12. Knock-out blanking plate 380 x 71 mm

Note:

The cabinet in the drawing is shown without any panels or doors.

B-B section

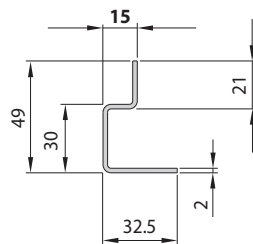
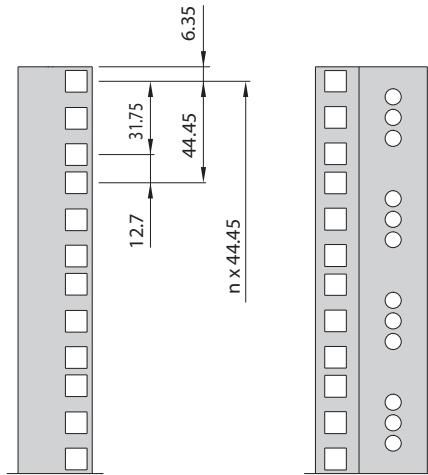
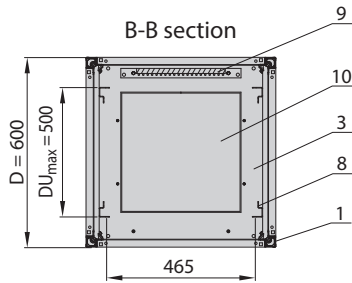

19" mounting profile
type STANDARD
15 mm deep